

V-07003-Li Ventilbalken und Oberteile

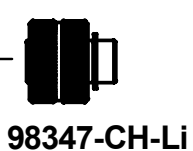
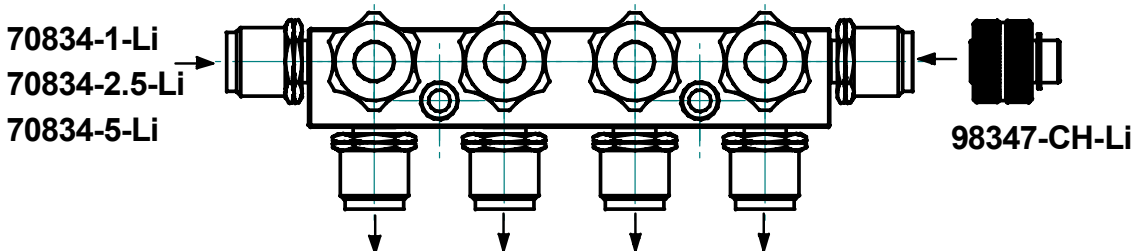
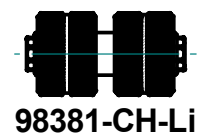
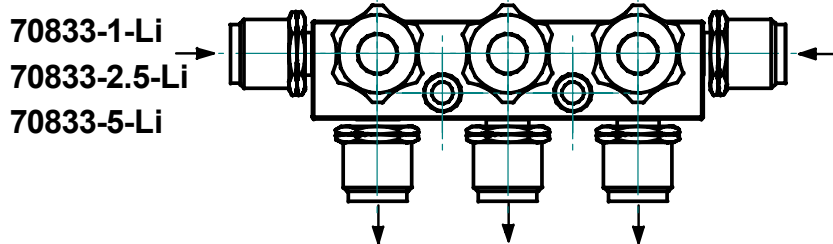
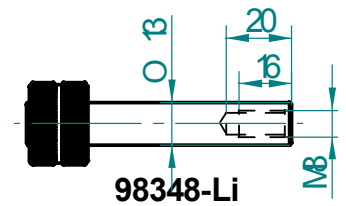
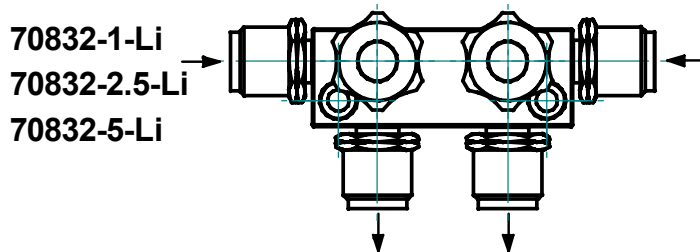
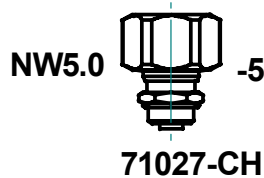
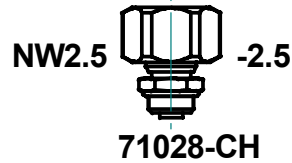
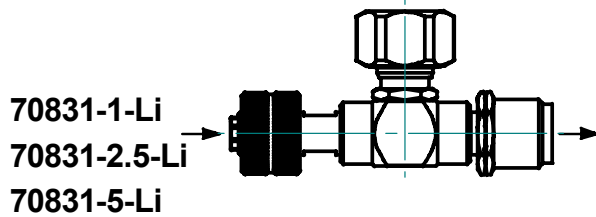
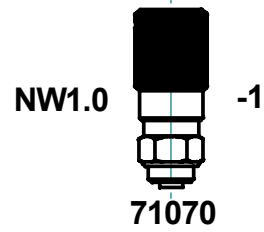
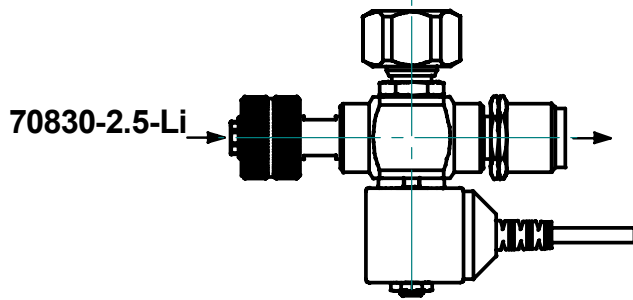

OR- G1/2" Anschluss- System gemäss V-08010-Li